



Orion-Tr Smart DC-DC Charger Non-Isolated

Table of Contents

1. Safety precautions	1
2. Introduction	2
3. Features	3
4. Installation	4
4.1. Mounting	4
4.2. Cable and fuse recommendations	4
4.3. Polarity check before connecting the battery	6
4.4. Recommended torque	6
4.5. Connection setup for DC-DC power supply mode	7
4.6. Connection setup for charger mode	7
4.7. Remote on/off wiring	8
4.8. Engine shutdown detection override	9
5. Engine shutdown detection	11
5.1. Engine shutdown detection sequence	11
5.2. Engine shutdown detection setup with VictronConnect	12
6. LED Indicators	14
7. Troubleshooting	15
7.1. The charger does not power up	15
7.2. The battery does not charge	17
7.3. Bluetooth connection issues with VictronConnect	19
7.4. Error codes	20
8. Specifications	21
9. VictronConnect - Orion Smart DC-DC Charger	22
9.1. Introduction	22
9.2. Live Data Information	22
9.2.1. Instant Readout over BLE	22
9.2.2. Charger Mode - STATUS tab	22
9.2.3. Charger Mode - GRAPH tab	23
9.2.4. Power Supply Mode	23
9.3. Settings	24
9.3.1. Charger Mode	24
9.3.2. Charger Mode - Battery Settings	24
9.3.3. Power Supply Mode	25
9.4. Product Information	25
10. Appendix	27
10.1. Dimension drawing	27

1. Safety precautions



- Read this manual carefully before installing and operating the product. It contains important instructions that must be followed during installation, operation and maintenance.
- Save these instructions for future reference on operation and maintenance.



- Never use the product at sites where gas or dust explosions could occur.
- Never place the charger on top of the battery when charging.
- Prevent sparks close to the battery. A battery being charged could emit explosive gasses.
- Danger of explosion from sparking.
- Danger of electric shock.
- Install the product in a heatproof environment. Ensure that there are no chemicals, plastic parts, curtains or other textiles, etc., in the immediate vicinity of the equipment.
- Ensure that the equipment is used under the correct operating conditions. Never operate it in a wet environment.
- It is normal for the Orion Smart DC-DC charger to get hot during operation; keep any heat-sensitive objects away and provide proper ventilation.
- For very hot environments, consider mechanical air extraction.
- The Orion-Tr Smart DC-DC Charger is potted inside. Because of this, there is a noticeable smell when running at maximum power (or close to it) and getting warm/hot. This smell is not harmful to health.
- Avoid covering the charger.
- Refer to the specifications provided by the battery manufacturer to ensure that the battery is suitable for use with this product. The battery manufacturer's safety instructions should always be observed.
- In addition to this manual, the system operation or service manual must include a battery maintenance manual applicable to the type of batteries used.
- This device is not to be used by persons (including children) with reduced physical, sensory or mental capabilities or lack of experience and knowledge unless they have been given supervision or instruction.



- Use flexible multi-stranded copper cables for the connections. The maximum diameter of the individual strands is 0,4mm/0,125mm² (0.016 inch/AWG26). Check the [Cable and fuse recommendations \[4\]](#) section for details.
- The installation must include a fuse in accordance with the recommendations in the table [Cable and fuse recommendations \[4\]](#).
- The product is not protected against reverse polarity. Be sure to check polarity before and during battery connection. For details, see [Polarity check before connecting the battery \[6\]](#).

2. Introduction

The Orion-Tr Smart DC-DC Charger can be used as a power supply or battery charger. In charger mode, the three-state charge algorithm will increase battery life by properly charging the battery. Especially in the case of vehicles with a smart alternator, controlled charging is indispensable. Controlled charging will also protect the alternator in lithium systems where direct charging can overload the alternator due to the low impedance of the lithium battery. In fixed output mode, the output voltage will remain stable independent of the applied load or varying input voltage (within the specified range).

The Orion-Tr Smart DC-DC Charger can be set up to only provide power when the engine is running. This is possible thanks to the built-in engine shutdown detection. This also prevents the onboard voltage of the vehicle from becoming too low. It is not necessary to intervene in the vehicle system, to install a separate motor run sensor or to intervene in the CAN-bus system. Apart from this detection, the Orion smart charger can also be activated by a forced allowed-to-charge feature, e.g. connected to the ignition switch.

The Orion-Tr Smart DC-DC Charger is configured and monitored via the VictronConnect app. Discover all setup possibilities in the [VictronConnect manual](#).



3. Features

Smart alternator compatibility

Vehicle manufacturers are now introducing smart ECU (Engine Control Unit) controlled alternators to increase fuel efficiency and reduce emissions. Smart alternators deliver a variable output voltage and are shut down when they're not needed. The converter has an engine-running detection mechanism. This prevents the converter from discharging the starter battery when the alternator does not supply power. See section 5 of this manual for more details.

Separation of the starter battery and the service battery

The Orion-Tr Smart DC-DC Charger separates the starter and service batteries when the engine is not running.

Extensive electronic protection

Over-temperature protection and power derating when temperature is high.

- Overload protected.
- Short circuit protected.
- Connector over-temperature protection.

Adaptive three-step charging

The Orion-Tr Smart DC-DC Charger is configured for a three-step charging process:

Bulk – Absorption – Float.

Bulk

During this stage, the controller delivers as much charge current as possible to rapidly recharge the batteries.

Absorption

The controller switches to constant voltage mode when the battery voltage reaches the absorption voltage setting. For lead acid batteries, it is important that the absorption time is kept short during shallow discharges to prevent overcharging of the battery. After a deep discharge, the absorption time is automatically increased to make sure that the battery is completely recharged. For lithium batteries, absorption time is fixed, default 2 hours. The fixed or adaptive mode can be chosen in the battery settings, and the minimum absorption time for the adaptive or fixed absorption time mode is adjustable via VictronConnect.

Float

During this stage, float voltage is applied to the battery to maintain it in a fully charged state. When the battery voltage drops substantially below this level due to a high load, for example, for at least 1 minute, a new charge cycle will be triggered.

Flexible charge algorithm

Programmable charge algorithm and eight preprogrammed battery settings. Configurable with VictronConnect.

Adaptive absorption time

Automatically calculates the proper absorption time. Configurable with VictronConnect.

Configuring and monitoring

Bluetooth Smart built-in: the wireless solution to set up, monitor and update the controller using Apple and Android smartphones, tablets or other devices. Several parameters can be customized with the VictronConnect App.

The VictronConnect App can be downloaded from: <https://www.victronenergy.com/support-and-downloads/software>

Use the [VictronConnect manual](#) - to get the most out of the VictronConnect App when connected to an Orion Smart.

Input voltage lock-out

Shut down if the input voltage drops below the lock-out value and restart when the input voltage increases above the restart value. Configurable with VictronConnect.

Remote on/off

Use the remote function to enable and disable the charger remotely with the remote on/off connector or the VictronConnect App. Typical use cases include a user-operated hard-wired switch and automatic control by, for example, a Battery Management System.

4. Installation

4.1. Mounting

- Mount vertically on a non-flammable surface, with the power terminals facing downwards.
- Observe a minimum clearance of 10 cm under and above the product for optimal cooling.
- Mount close to the battery, but never directly above the battery to prevent damage due to gassing of the battery.
- Please see the [Appendix \[27\]](#) of this manual for the dimension drawing; this drawing also indicates the mounting holes.

4.2. Cable and fuse recommendations



- Use flexible multi-stranded copper cables for the battery connections.
- The diameter of the individual strand of the cable used should not exceed 0.4mm (0.016 inch) or have a surface area exceeding 0.125mm² (AWG26).
- The maximum operating temperature is 90°C (194°F).
- A 16mm² cable, for example, should have at least 122 strands (class 5 or higher stranding according to VDE 0295, IEC 60228 and BS6360). Example of suitable cable: class 5 "Tri-rated" cable (it has three approvals: American (UL), Canadian (CSA) and British (BS)).
- In the case of thicker strands, the contact area will be too small, and the resulting high contact resistance will cause severe overheating, eventually resulting in fire. See the below figure for examples of what cable to use and not to use.



Cable type recommendation

For correct connection of a cable to the input/output screw terminals, stranded wires with flexible and very flexible cores can be used according to:

- IEC 60228 - Class 2 (stranded), Class 5 (flexible), Class 6 (very flexible)
- UL486A-B - Class B/C (stranded), Class I (flexible), Class K (very flexible)

Cables with twisted cores are very stiff, which means that they are rarely used in practice. The table below provides an overview of how to recognise the different wire classes.

Single wire diameter in the bundle				
Nominal cross-section	Class 5 (IEC)	Class 6 (IEC)	Class I (UL)	Class K (UL)
9AWG			24AWG	30AWG
6mm ²	0.3mm	0.2mm		
7AWG			24AWG	30AWG
10mm ²	0.4mm	0.2mm	-	-
6AWG	-	-	24AWG	30AWG
16mm ²	0.4mm	0.2mm	-	-
4AWG	-	-	24AWG	30AWG

The use of ferrules is not required for cables from the above table. If an even thinner cable is used, a ferrule can help to bundle the loose wires. However, it is up to the installer to make sure that the cable is properly secured. With or without a ferrule, the connecting cable must be adequately clamped to ensure low contact resistance.

Preparation for correct mounting of fine strand wires in the screw terminal block

1. Cut the cable straight with no loose or staggered threads. Using a wire cutter will result in a straight cut.
2. Make sure no fine wires are cut when stripping the insulation.
3. Open the screw on the screw terminal block completely to prevent fine wires from getting caught behind the screw and bunching up. Pay particular attention to this when using the maximum wire diameter.
4. Tighten the screw with the correct torque; see [Recommended torque \[6\]](#) and note the wire size and wire class. Never apply less than the recommended torque.
5. Hold the recommended torque for at least 5 seconds, this will give the screw time to settle to the set torque. This maximises the force on the wire, thereby maintaining a gas-tight contact pattern during heating and cooling cycles over time. Take the time to do it right. This is important. This is a UL486 test requirement and a requirement for all factory and field installations.

Fuse recommendation

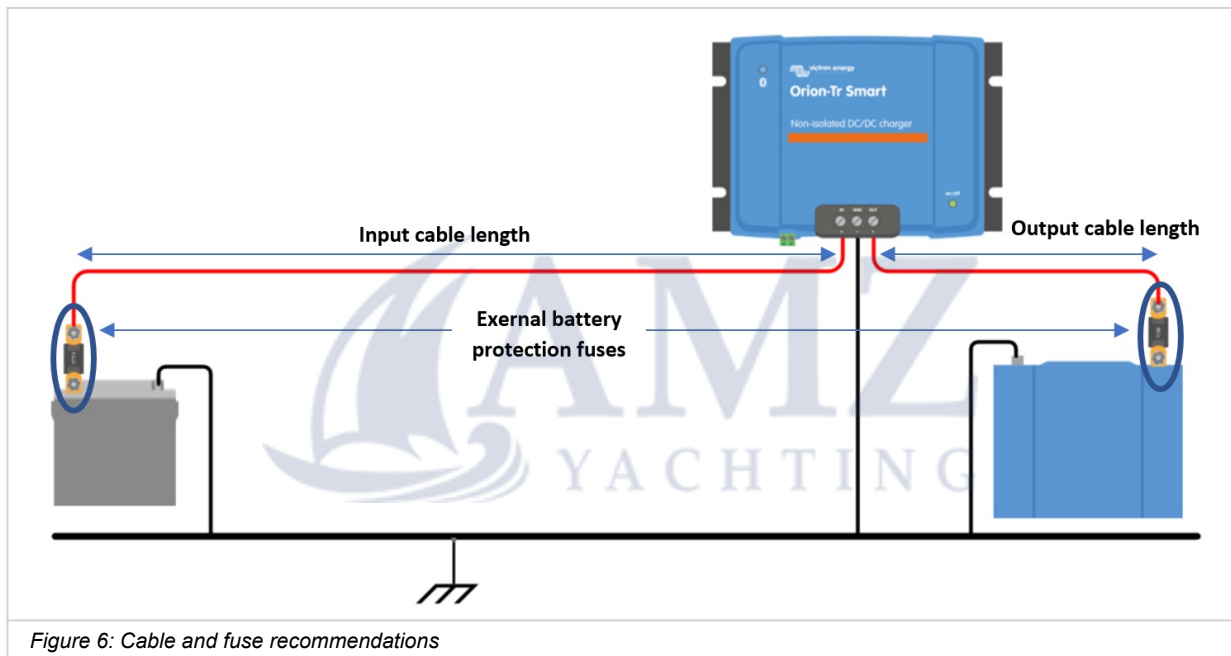

Voltage rating (Input or output)	External battery protection Fuse	Minimum cable gauge				
		0.5m	1m	2m	5m	10m
12V	60A	6mm ²	10mm ²	10mm ²	16mm ²	16mm ²
24V	30A	4mm ²	6mm ²	6mm ²	10mm ²	10mm ²

4.3. Polarity check before connecting the battery



The Orion Smart DC-DC Charger is not protected against reverse battery polarity; any damage caused by this is not covered under warranty. A device damaged by reverse polarity cannot be repaired.

Always verify the battery polarity before connecting or reconnecting the battery cables to the Orion smart charger.

Do not attempt to attach the battery cables to the Orion unless the input and output terminals are safely accessible.

Be careful not to bend individual strands when inserting the cables into the input and output terminals.

Connect the battery cables to the Orion first, verify battery polarity again and only then connect the battery.



A device damaged by reverse polarity cannot be repaired. Do not attempt to open the device. The device is potted and contains no serviceable parts or fuses that can be replaced.

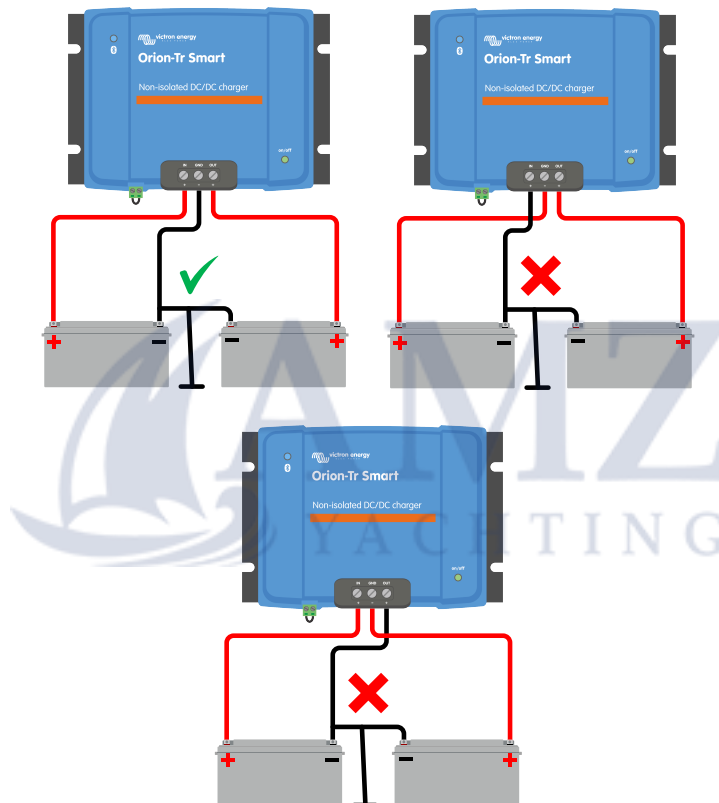

4.4. Recommended torque



Torque: 1.6 Nm

4.5. Connection setup for DC-DC power supply mode

1. Disconnect the remote on/off; remove the wire bridge or unplug the terminal block.
2. Connect the input supply cables.
3. Open the VictronConnect App to set up the product, see [Power Supply Mode \[23\]](#) (always adjust the output voltage before connecting in parallel or connecting a battery).
4. Connect the load. The Orion is now ready for use as a power supply.
5. Reconnect the remote on/off to activate the product.

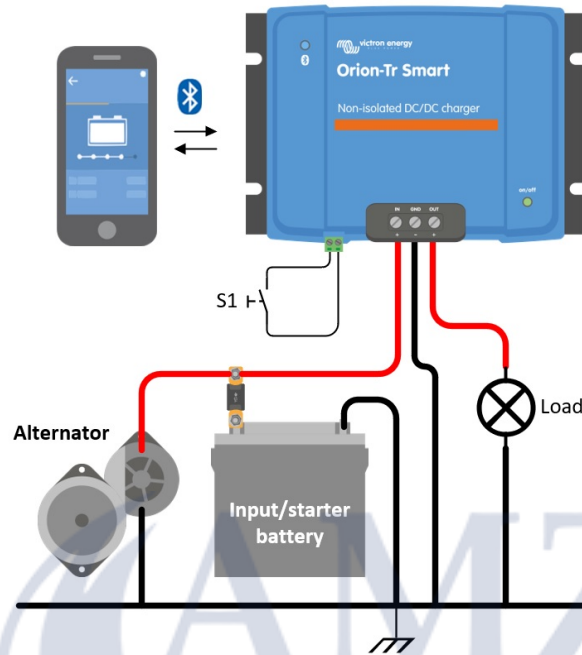

Figure 1: Typical connection setup as DC-DC power supply

4.6. Connection setup for charger mode

1. Disconnect the remote on/off; remove the wire bridge or unplug the terminal block.
2. Connect the input supply cables.
3. Open the VictronConnect App to set up the product, see [Charger Mode \[24\]](#) (always set up the correct charger algorithm before connecting a battery).
4. Connect the battery to be charged.
5. Reconnect the remote on/off to activate the product.

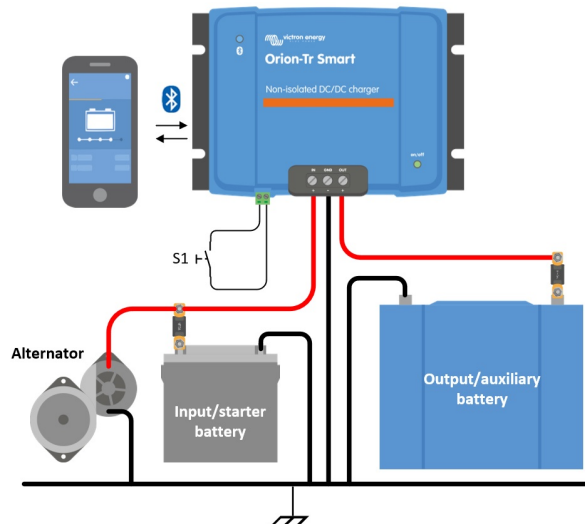

Figure 2: Typical connection setup as charger

4.7. Remote on/off wiring

The recommended use of the remote on/off is:

- A switch wired between the L-H pins (On-level impedance between L-H pins: $< 500\text{k}\Omega$)
- A switch wired between (input/starter) battery plus and H-pin (on level: $> 3\text{V}$)
- A switch between the L-pin and (input/starter) ground (on level: $< 5\text{V}$)
- BMS control through the H-pin



Voltage tolerance L & H pin: $\pm 70\text{V}_{\text{DC}}$

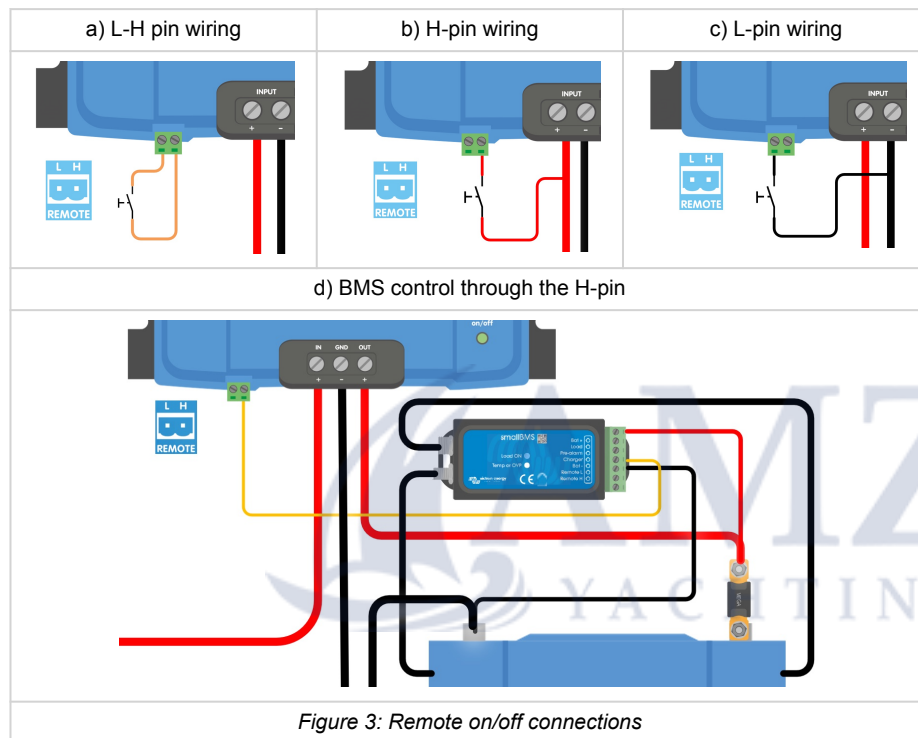

Figure 3: Remote on/off connections

4.8. Engine shutdown detection override

In charger mode the “engine shutdown detection sequence” determines if conditions are met to enable charging, see [Engine shutdown detection \[11\]](#). The “engine shutdown detection override” forces the charger to allow charging independently of the engine shutdown detection. Engine shutdown detection override is activated by applying >7V to the remote L-pin. This allows external control (e.g. ignition switch, CAN bus engine on detector) to enable charging.



This function does not override the remote on/off function. Remote connection a), b) or d), as shown in Figure 3 must be configured in combination with engine shutdown detection override. See examples in figure 4.

Enable charging with an ignition switch and remote on/off option a)

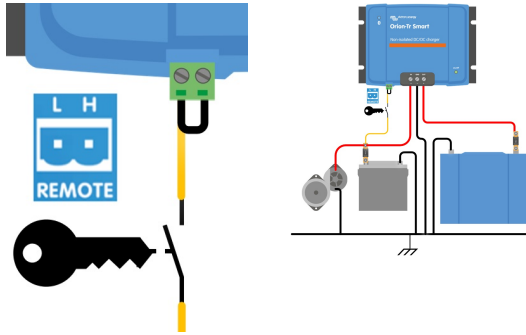

Enable charging with an ignition switch and remote on/off option d)

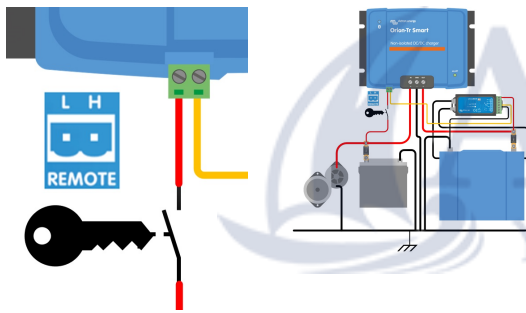

Figure 4: Engine shutdown detection override connection diagram



If the ignition switch in figure 4 is switched off, the charger will return to “engine shutdown detection” mode, it will not turn off the charger.

To force enable/disable charging (i.e. turn the ORION on/off) without the “engine shutdown detection”, a remote option as given in [Remote on/off wiring \[8\]](#) must be wired, and the engine shutdown detection must be switched off in VictronConnect, see figure 5.

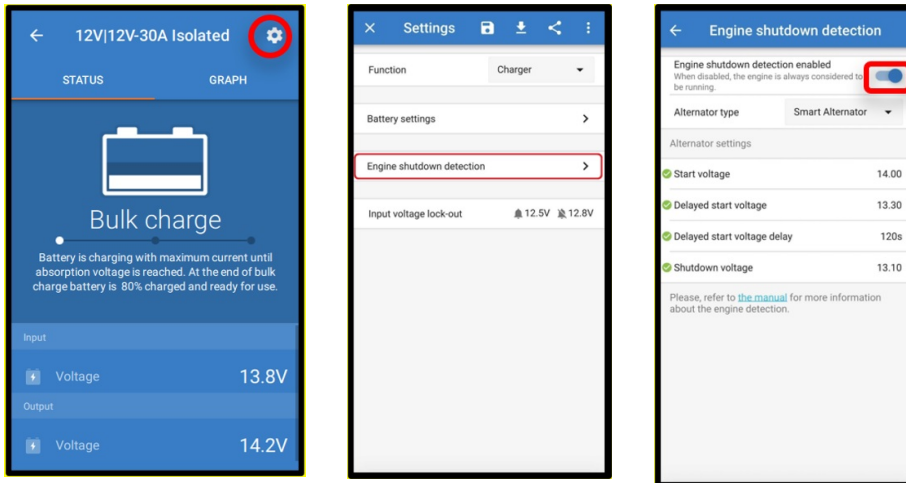



Figure 5: Disable engine shutdown detection

- 

When the engine shutdown detection has been switched off in Victron Connect ('forced charging'), **current will be drawn from the starter battery even if the engine is not running.**
- 

During 'forced charging' the input voltage lockout is the only limit left to disable charging automatically; make sure this level is not set too low, in most applications 12.5V is sufficiently low.



5. Engine shutdown detection

The engine shutdown detection mechanism simplifies your ORION-Tr DC-DC Charger system by detecting if the engine is running without wiring additional switches or sensors. The factory default setting will work with most regular and smart alternators but can be re-configured with the VictronConnect App.

Configuring the engine shutdown detection depends on the voltage the alternator generates when the engine is running. Regular alternators generate a fixed voltage (e.g. 14V), whereas smart alternators generate a variable output voltage ranging from 12.5V to 15V. Especially smart alternators in a regenerative braking system show significant alternator voltage variations.

Engine shutdown detection is only active in charger mode. The feature can be disabled by the “engine shutdown detection override” and in VictronConnect. In power supply mode, the “input voltage lock-out” determines when the output is active.



The engine shutdown detection is updated from software version v1.05 onwards.

5.1. Engine shutdown detection sequence

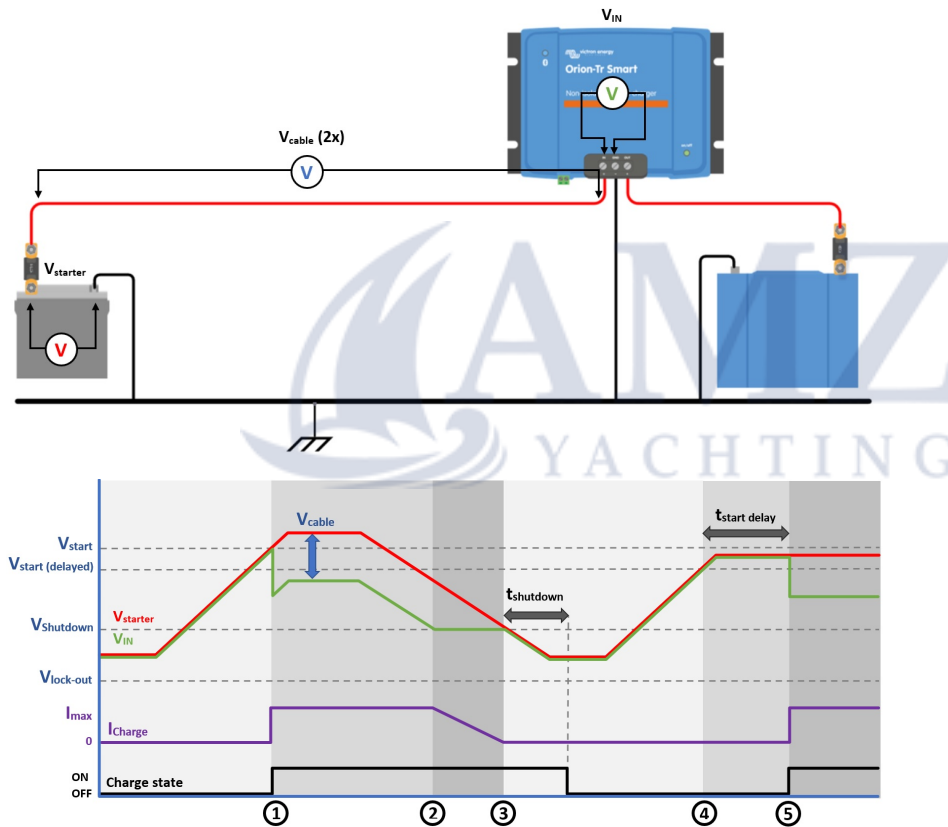

Figure 8: Engine shutdown detection sequence

0 → 1: If the engine runs the alternator voltage will ramp-up, when $V_{\text{starter}} > V_{\text{start}}$, charging is enabled.

1 → 2: The input current produces a voltage across the input cable (V_{cable}); this voltage reduces the voltage measured by the charger (V_{IN}). If $V_{\text{IN}} > V_{\text{shutdown}}$ the charger will operate at I_{max} .

2 → 3: If $V_{\text{IN}} \leq V_{\text{shutdown}}$, the charge current will be reduced to prevent V_{IN} to drop below V_{shutdown} .

3 → 4: If $V_{\text{IN}} < V_{\text{shutdown}}$ for longer than 1 min (t_{shutdown}) “engine off” is detected and charging is disabled. If $V_{\text{IN}} > V_{\text{shutdown}}$ before t_{shutdown} runs out, charging remains enabled.

4 → 5: If $V_{\text{start}(\text{delay})} < V_{\text{IN}} < V_{\text{start}}$ charging is enabled after $t_{\text{start delay}}$ (configurable).

5.2. Engine shutdown detection setup with VictronConnect

Open VictronConnect and press the cog symbol  to enter the settings.

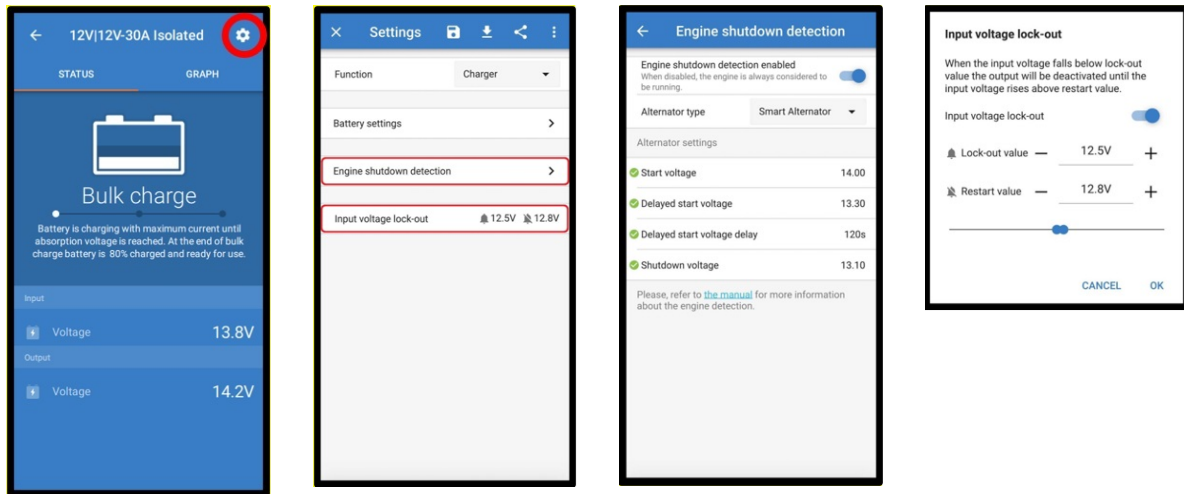

Figure 9: Engine shutdown detection setup menu

The following settings can be changed with VictronConnect:



The default values displayed are for the 12V input models. Those values are scaled depending on the input voltage of the model. E.g. for 24V input models, the default values displayed on the manual should be multiplied by 2.

Engine shutdown detection enabled: The engine shutdown detection is always enabled by default when the charger mode is selected. When it is disabled by the user or when power supply mode is selected, the engine is considered to be running, so no shutdown detection will take place.

Alternator type: The alternator type can be selected between “Smart Alternator”, “Regular Alternator”, and “User defined”. When the “Smart Alternator” option is selected, the default values for the smart alternator are/will be applied to the engine shutdown detection settings. The same will happen when the “Regular Alternator” option is selected. When any settings differ from the default values of the last two options, the “User defined” option will be selected. Default: “Smart Alternator”.

Start voltage (V_{start}): At this level, charging starts immediately. Default: 14V.

Delayed start voltage ($V_{start(delay)}$): Smart alternators can generate a lower voltage when the engine is running; therefore, a lower start level is necessary for these systems. To ensure that the starter battery is recharged after starting the engine, charging of the auxiliary battery is delayed during this condition. The energy used during starting must be replenished to ensure that the starter battery remains properly charged. Default: 13.3V (Smart Alternator) and 13.8 (Regular Alternator).

Delayed start voltage delay ($t_{start delay}$): Recharge time for the starter battery during start level (delayed). Example: If the starter draws 150A for 5sec to start the engine, about ~0.2Ah is drawn from the starter battery. If, during engine idling, the alternator can only generate 20A, it takes $150A/20A \times 5sec = 37.5sec$ to recharge the starter battery. Default: 2 minutes.

Shutdown voltage ($V_{shutdown}$): This level corresponds with the engine being off. This keeps the starter battery fully charged and provides a hysteresis with respect to the start level. The hysteresis must be large enough to prevent V_{IN} to drop to $V_{shutdown}$, which would result in charge current reduction. Action will be taken after $t_{shutdown}$ runs out (1 minute); this allows charging during temporary low voltage conditions. Default: 13.1V (Smart Alternator) and 13.5V (Regular Alternator).

Range for engine start/shutdown levels:

- 12|12; 12|24: 8 to 17V
- 24|12; 24|24: 16 to 35V

Setup input voltage lock-out: Input voltage lock-out is the minimum level at which charging is allowed; below this level, charging stops immediately. Default (in charger mode): lock-out: 12.5V / restart: 12.8V. Default (in power supply mode): lock-out: 10.5V / restart: 12V.



When ‘forced charging’ is enabled, current will be drawn from the starter battery if the engine is not running. Setting the lock-out level very low can result in a depleted starter battery.

To set up input voltage lock-out, two criteria are important:

- **Minimum alternator voltage:** A smart alternator can operate at very low alternator voltage (<12.5V), e.g. when the vehicle accelerates. This low voltage is allowed during tshutdown as shown in "engine shutdown detection sequence 3→4". If charging must remain enabled during this period, the lock-out level must at least be set below the minimum alternator voltage.



If the low voltage period exceeds tshutdown charging will be disabled on engine shutdown detection.

- **Voltage drop across the input cable:** As seen in "engine shutdown detection sequence 1→3", V_{IN} will be lowered by V_{cable} . When the alternator voltage drops fast (smart alternator), the charge control needs some time to reduce the charge current and keep V_{IN} at $V_{shutdown}$. During this time V_{cable} must not trip the voltage lock-out. Therefore, the lock-out value should be: $V_{lock-out} \leq V_{shutdown} - V_{cable}$.

Example: Calculate the input cable voltage drop:

- Distance between starter battery and charger: 5m.
- $V_{shutdown} = 13.1V$. Recommended wire gauge: 16mm².
- Cable resistance: $\sim 1.1m\Omega/m$ @20°C, thus $R_{cable} = 1.1m\Omega \times 10m$ (2x 5m) = 11mΩ.
- A 12|12-30A Smart Charger will draw about 35A from the input when running at full capacity, resulting in:
 - $V_{cable} = 11m\Omega \times 35A = 385mV$.
 - $V_{lock-out} \leq V_{shutdown} - V_{cable} = 13.3V - 385mV \approx 12.9V$.



Cable connections, external fuses, temperature, etc., influence the total cable resistance.



6. LED Indicators

The Orion features two LEDs, the blue LED is dedicated to Bluetooth functionality, and the green LED indicates the product status as per the list below.

Green Status LED

- **LED off:**
 - No input voltage
 - Remote shutdown;
 - Shutdown by the user;
 - Connector overtemperature protection
 - User-defined undervoltage lock-out
 - Engine off detected (when in Charger mode)
- **LED on:**
 - Output active on Power supply mode
 - Charger in Float State (Battery charged);
- **LED blinking every 0.8 seconds:**
 - Charger in Bulk or Absorption State (Battery is being charged);

Blue Bluetooth LED

- **LED off:**
 - No input voltage;
- **LED blinking every 3 seconds:**
 - Error – needs to be checked on VictronConnect; see also [Error codes \[20\]](#) for an overview of all Orion error codes displayed in VictronConnect.
- **LED blinking every 0.8 seconds:**
 - Connected via Bluetooth
- **LED blinking every 0.4 seconds:**
 - Identify;
- **LED Blinking once every 5 seconds:**
 - Charger off due to non-error conditions as:
 - Remote shutdown;
 - Shutdown by the user;
 - User-defined undervoltage lock-out;
 - Engine off detected (when in Charger mode);
- **LED on**
 - All other conditions

7. Troubleshooting

Consult this chapter in case of unexpected behaviour or if you suspect a product fault.

The correct troubleshooting and support process is to first consult the common issues as described in this chapter.

If you experience problems with VictronConnect, first consult the [VictronConnect manual](#), especially the troubleshooting chapter.

Should all this fail to resolve the issue, scan through popular questions and answers regarding your product and ask the community of experts in the [Victron Community](#). In case the problem persists, contact the point of purchase for technical support. If the point of purchase is unknown, refer to the [Victron Energy Support webpage](#).

7.1. The charger does not power up

With a normally working charger powered on and operational, the controller LED(s) - check the [LED Indicators \[14\]](#) - will illuminate or blink and can communicate the charger status and battery voltages via VictronConnect. This is not possible with a device that does not turn on.

If the device does not power up, use the following steps to check why the charger is not operational.

1. Check for mechanical damage to its housing and input/output terminals.
If there is mechanical damage, this is probably the cause of the problem.
2. Check the device for burn marks and a burning smell.
If there are burn marks, this is probably the cause of the problem. Note that the device is potted; therefore, there may be some smell if it gets warm/hot while charging.
3. Measure the battery voltage at the charger battery terminals with a multimeter to rule out possible problems with the wiring, fuses and/or circuit breakers in the path between the battery and charger.

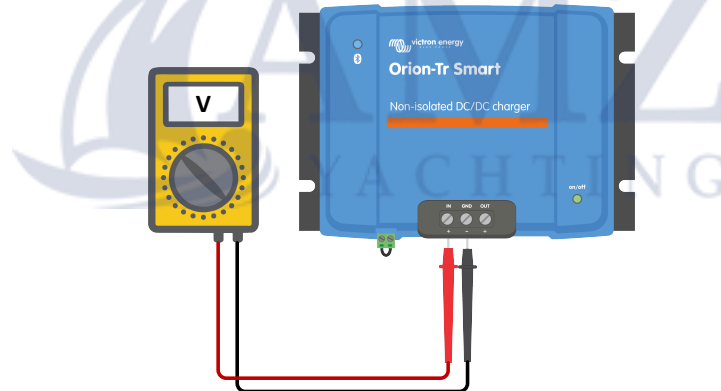

Depending on the result of the measurement, do the following:

Battery voltage	Operational state	Action to take
No voltage	Off	Restore the battery supply: - check external fuses - check for loose wires and damaged cables - check for bad crimps and pull-test the wires
Correct voltage	Off	There might be a fault with the charger. Contact your Victron dealer or distributor. The charger was accidentally connected with the battery polarity reversed (see Polarity check before connecting the battery [6] , not covered under warranty). Replace the charger.

Battery voltage	Operational state	Action to take
Correct voltage	Off because the remote link is not connected	Restore the remote link: The minimum requirement for the remote on/off terminal is a wire loop between the L- and H-pins. If a BMS controls the Orion's remote on/off, ensure this connection works as outlined in Remote on/off wiring [8] .



7.2. The battery does not charge

There are a number of reasons why the Orion Smart might not charge the batteries. The following steps are intended to help with troubleshooting and corrective measures.

Reasons why the battery does not charge are:

- Issues with the battery or system wiring
- Incorrect settings, such as battery settings, input voltage lock-out and engine shutdown detection
- A BMS or other device remotely controls the Orion Smart via its remote on/off
- If not controlled by its remote on/off, it is missing the wire loop between L- and H-pin

1. First, check if the VictronConnect app shows on the status page why charge is disabled.

This can be because the remote input is inactive, the charger is disabled in the battery settings, or charge is disabled because input voltage lock-out and/or engine shutdown was detected.

VictronConnect message	Action to take
Remote input inactive	Consult the Remote on/off wiring [8] and check the wiring. Check the terminal block for the remote on/off function is plugged in. Check for continuity if a wire loop or simple switch is used between L- and H-pin. If a BMS controls the remote input, ensure the ATC connection works.
Disabled in settings	Enable the charger in the battery settings.
Input voltage lock-out	See step 3.
Engine shutdown detected	See step 4.

2. Check the battery wiring for damaged cables, loose connections, bad crimps or a blown battery fuse.

Are the wires stripped to the correct length and tightened with the correct torque?

What to check	Action to take
Are you using the correct cables, and are the wires stripped to the correct length, tightened with the correct torque and making good contact with the plug/terminals?	See Recommended torque and Cable and fuse recommendations [4] .
Are there any burn marks on the terminals, or are the cables or connectors molten?	Replace the device. This damage is usually not covered by warranty.

3. Check the battery settings in the VictronConnect App.

Incorrect battery settings can cause the charger to switch to absorption or float charging prematurely. The battery is then not fully charged.

Description/Symptom	Action to take
The battery does not get fully charged.	Check the absorption voltage in the battery settings and ensure it is set to the values the manufacturer recommends. See Charger Mode - Battery Settings [24] . Make sure Charger mode is enabled in the settings. The power supply mode does not follow any charging algorithm, and the output voltage might be set too low.
The battery does not get fully charged, but the Input voltage lock-out is enabled, and the input voltage is below the lock-out value. This is accompanied by the message "Charge is disabled due to: Input voltage lock-out" on the status page in the VictronConnect app.	Ensure the input voltage is above the restart value or disable the input voltage lock-out feature in the settings. See Charger Mode [24] .

Description/Symptom	Action to take
<p>VictronConnect shows an output voltage higher than that of the charged battery as measured with a battery monitor or DMM.</p>	<p>In general, the voltage measured at the output of the charger is always higher than that of the battery connected to that output as long as a high current is flowing.</p> <p>However, a bad connection between the output and the battery terminal can lead to the same symptom. Check step 2 again and ensure the lowest possible resistance for all connections.</p>

4. Check the engine shutdown detection settings in the VictronConnect App.

Incorrect engine shutdown detection settings can result in the battery not being charged.

Description/Symptom	Action to take
<p>The battery will not charge because the start voltage value is too high for the selected alternator type (never reaches this voltage).</p> <p>This is accompanied by the message "Charge is disabled due to: Engine shutdown detected" on the status page in the VictronConnect app.</p>	<p>Lower the start voltage value and ensure the alternator supports it. See Engine shutdown detection setup with VictronConnect [12].</p>
<p>The battery is not fully charged because the shutdown voltage is set too high and the charger stops charging prematurely.</p> <p>This is accompanied by the message "Charge is disabled due to: Engine shutdown detected" on the status page in the VictronConnect app.</p>	<p>Increase the shutdown voltage value. See Engine shutdown detection setup with VictronConnect [12]</p>



7.3. Bluetooth connection issues with VictronConnect

In the normal state, the blue Bluetooth LED should blink every 0.8 seconds when there is a connection between the VictronConnect app and the Orion-Tr Smart DC-DC Charger. See the [LED Indicators \[14\]](#) section and learn more about the meaning of the different LED codes.

If not, check the following:

Blue LED status	LED duration	Action to take
Off	-	<p>No input voltage: The Bluetooth controller is powered by the battery connected to the input terminals. Restore the battery supply.</p> <p>Bluetooth has been disabled in the VictronConnect setting: This cannot be undone. We recommend leaving Bluetooth on at all times.</p> <p>The Bluetooth option "Enabled for 30 seconds" was selected on the product info page. This means Bluetooth is active for 30 seconds after powering up the Orion. After 30 seconds, Bluetooth turns off until the next power-up. Disconnect and reconnect the battery input cable. Then connect to the Orion via VictronConnect within 30 seconds and set the Bluetooth option to 'Enabled'.</p> <p>If none of the above applies, the unit may be faulty; submit a warranty claim.</p>
Blinking	Every 0.8 seconds	<p>There is already a Bluetooth connection active. Only one phone or tablet can connect via Bluetooth at a time; is perhaps another phone or tablet already connected? A clear indicator of this is that the Orion is visible in VictronConnect but greyed out.</p>
<p>For all other connection problems, please consult the VictronConnect manual for troubleshooting Bluetooth connection issues.</p>		



7.4. Error codes

The error codes are displayed in the VictronConnect app.

For the most up-to-date version of this list, see this link: <https://www.victronenergy.com/live/mppt-error-codes>.

Error 2 - Battery voltage too high

- This error will auto-reset after the battery voltage has dropped. This error can be due to other charging equipment connected to the battery or a fault in the charge controller.

Error 26 - Terminal overheated

- Power terminals overheated; check wiring, including the wiring type and type of strands, and/or fasten bolts if possible. This error will auto-reset.

Error 27 - Charger short circuit

- This condition indicates an over-current condition on the battery side. It can occur when a battery is attached to the unit using a contactor. Or in case the charger starts up without a battery connected but connected to an inverter with a large input capacitance.

This error will auto-reset. If the error does not auto-reset, disconnect the charge controller from all power sources, wait 3 minutes, and power up again. If the error persists, the charge controller is probably faulty.

Error 116 - Calibration data lost

- If the unit does not work and error 116 pops up as the active error, the unit is faulty. Contact your dealer for a replacement.

If the error is only present in the history data and the unit operates normally, this error can be ignored safely. Explanation: when the units power up for the first time in the factory, it does not have calibration data and an error 116 is logged. Obviously, this should have been cleared, but in the beginning, units left the factory with this message still in the history data.

Error 119 - Settings data lost

- The charger cannot read its configuration and stopped.

This error will not auto-reset. To get it working again:

1. First, restore it to factory defaults (top right in VictronConnect, click on the three dots).
2. Disconnect the charge controller from all power sources.
3. Wait 3 minutes, and power up again.
4. Reconfigure the charger

Please report this to your Victron dealer and ask him to escalate it to Victron, as this error should never happen. Preferably include firmware version and any other specifics (VRM URL, VictronConnect screenshots or similar).

8. Specifications

Table 1. Specifications

Orion-Tr Smart DC-DC Charger Non-Isolated 360 – 400 Watt	12/12-30 (360 W)	12/24-15 (360 W)	24/12-30 (360W)	24/24-17 (400W)
Input voltage range (1)	10-17 V	10-17 V	20-35 V	20-35 V
Under voltage shut down	7 V	7 V	14 V	14 V
Under voltage restart	7.5 V	7.5 V	15 V	15 V
Nominal output voltage	12.2 V	24.2 V	12.2 V	24.2 V
Output voltage adjust range	10-15 V	20-30 V	10-15 V	20-30 V
Output voltage tolerance	+/- 20mV			
Output noise	2 mV rms			
Cont. output current at nominal output voltage and 40°C	30 A	15 A	30 A	17 A
Maximum output current (10 s) at nominal output voltage	40 A	25 A	45 A	25 A
Short circuit output current	60 A	40 A	60 A	40 A
Cont. output power at 25°C	430 W	430 W	430 W	480 W
Cont. output power at 40°C	360 W	360 W	360 W	400 W
Efficiency	87%	88%	88%	89%
No load input current	< 80 mA	< 100 mA	< 100mA	< 80mA
Standby current	Less than 1 mA			
Galvanic isolation	200 V dc between input, output and case			
Operating temperature range	-20 to +55° C (derate 3% per °C above 40° C)			
Humidity	Max. 95% non-condensing			
DC connection	Screw terminals			
Maximum cable cross-section	16 mm ² AWG6			
Weight	12 V input and/or 12 V output models: 1.8 kg (3 lb) Other models: 1.6 kg (3.5 lb)			
Dimensions hxxwx	12 V input and/or 12 V output models: 130 x 186 x 80 mm (5.1 x 7.3 x 3.2 inch) Other models: 130 x 186 x 70 mm (5.1 x 7.3 x 2.8 inch)			
Standards: Safety	EN 60950			
Emission	EN 61000-6-3, EN 55014-1			
Immunity	EN 61000-6-2, EN 61000-6-1, EN 55014-2			
Automotive Directive	ECE R10-5			
<p>1) If set to nominal or lower than nominal, the output voltage will remain stable within the specified input voltage range (buck-boost function). If the output voltage is set higher than nominal by a certain percentage, the minimum input voltage at which the output voltage remains stable (does not decrease) increases by the same percentage.</p> <p>Note 1) The VictronConnect App will not display current in or current out.</p> <p>Note 2) The Orion-Tr Smart DC-DC Charger Isolated is not equipped with a VE.Direct port.</p>				

9. VictronConnect - Orion Smart DC-DC Charger

9.1. Introduction

Thank you for using VictronConnect. This guide will help you get the most out of your Orion Smart DC-DC Charger and it requires a minimum knowledge of this charger that can be found in the [introduction](#). The information available here applies to all Orion Smart DC-DC Chargers. To simplify the reference to the Orion Smart DC-DC Charger, it will be referred to as just Orion Smart in this guide.

More general information about the VictronConnect App - how to install it; how to pair it with your device; and how to update firmware, for example - can be found by referring to the overall [VictronConnect manual](#).

Note: Where input and battery voltage is referred to in these instructions, a 12V input and battery is assumed. Please multiply the given values by 2 to arrive at settings for an installation configured for 24V.

9.2. Live Data Information

9.2.1. Instant Readout over BLE

VictronConnect can display key data of the Orion Smart (and other compatible smart products) on the Device list page without the need to connect to the product. This includes visual notifications of warnings, alarms, and errors that enable diagnostics at a glance.

The advantage is:

- Better range than a regular Bluetooth connection
- No need to connect to the smart product
- Key data at a glance
- Encrypted data



Please see the [Instant Readout chapter](#) in the VictronConnect manual for more information and how to set it up.

9.2.2. Charger Mode - STATUS tab

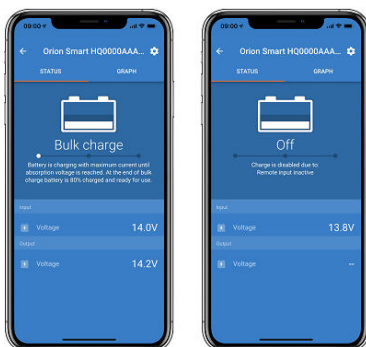

- **Orion Smart [SERIAL NUMBER]** confirms the connected device. A custom name can also be set if desired.
- **Mode icon** shows in which mode the Orion Smart is operating (**Charger** in this case)
- **Charger State:**

- **Bulk:** During this stage the Orion Smart delivers as much charge current as possible to rapidly charge the batteries. When the battery voltage reaches the Absorption voltage setting, the Orion Smart activates the Absorption stage.
- **Absorption:** During this stage the Orion Smart switches to the constant voltage mode, where a pre-set absorption voltage, suitable to the battery type (See *Settings* below), is applied. When the Absorption time is elapsed, the Orion Smart activates the Float stage.
- **Float:** During this stage the float voltage is applied to the battery to maintain a fully-charged state. When the battery voltage drops below Re-bulk voltage during at least 1 minute, a new charge cycle will be triggered.
- **Input Voltage** shows the voltage measured on the input terminals of the device.
- **Output voltage** shows the voltage measured on the output terminals of the device.
 - When the Orion Smart is on Off state, it will not measure the output voltage, so this value will appear as '—'
- **Off Reason** shows the reason why the Orion Smart is disabled (appears under the “Charger State” text when the Orion Smart is Off)

9.2.3. Charger Mode - GRAPH tab

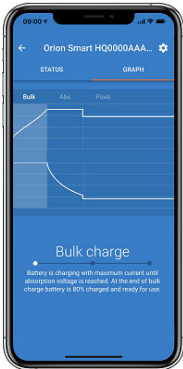

- **Orion Smart [SERIAL NUMBER]** confirms the connected device. A custom name can also be set if desired.
- **Charger State Graph** indicate in which state the charger currently is and show a short description of the current state.

9.2.4. Power Supply Mode



- **Orion Smart [SERIAL NUMBER]** confirms the connected device. A custom name can also be set if desired.
- **Mode icon** shows in which mode the Orion Smart is operating (**Power Supply** in this case)
- **Input Voltage** shows the voltage measured on the input terminals of the device
- **Output voltage** shows the voltage measured on the output terminals of the device
 - When the Orion Smart is on Off state, it will not measure the output voltage, so this value will appear as '—'
- **Off Reason** shows the reason why the Orion Smart is disabled (appears under the “Power Supply Mode” text when the Orion Smart is disabled)

9.3. Settings

VictronConnect allows the user to change and adjust several different settings from the Orion Smart. This is done through the settings option that can be accessed by clicking the  icon on the right top corner of the screen. The settings options are different according to the operation mode that is selected.

9.3.1. Charger Mode

When on Charger Mode, these are the available settings.

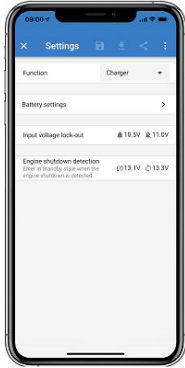

- **Function** allow to choose between “Charger” or “Power supply”. When charger mode is selected, the Orion Smart will follow the three state charge algorithm. For more information about the charge algorithm, please read the [Orion Smart manual](#).
- **Battery settings** allow to change the battery settings in order to adjust the absorption voltage, float voltage and others to fit the battery being charged. The battery setting is explained better on the next item.
- **Input voltage lock-out** allow to choose between two thresholds. One to set the lock-out and another one to reset it. Normally, a minimum 0.5V (for 12V input Orion Smart) difference is used for a better performance. The protection can still be disabled if desired by the user. For more information about the input voltage lock-out, please read the [Orion Smart manual](#).
- **Engine shutdown detection** allow to choose between two thresholds. One to set the detect the engine shutdown and another one to detect when it is running. Normally, a minimum 0.2V (for 12V input Orion Smart) difference is used for a better performance. The engine shutdown detection can still be disabled if desired by the user. For more information about the engine shutdown detection, please read the [Orion Smart manual](#).

9.3.2. Charger Mode - Battery Settings



- **Charger enabled**
 - Toggling this setting turns the Orion Smart off. The batteries will not be charged.
- **Charger settings - Battery preset**
 - Battery preset allows to select the battery type; accept factory defaults; or enter your own preset values to be used for the battery charge algorithm. The Absorption voltage, Float voltage, Bulk time limit, Re-bulk voltage offset, Adaptive absorption time and Absorption time, settings are all configured to a preset value - but can be user-defined.
 - User-defined presets can be stored in the preset library - in this way installers will not have to define all the values each time they are configuring a new installation.
 - By selecting Edit Presets, custom parameters can be set as follows:
 - **Absorption voltage**

- Set the absorption voltage
- **Float voltage**
 - Set the float voltage
- **Bulk time limit**
 - Set the maximum bulk time allowed for the charger.
- **Re-bulk offset voltage**
 - The re-bulk offset voltage determines what is the offset between the float voltage (or absorption if it is lower) and the re-bulk voltage. The re-bulk voltage is the battery voltage threshold that triggers another charge cycle. For example, when the charger cannot maintain the battery voltage due to a high load, the battery voltage will fall and a new charge cycle will be started once the battery voltage drops below the re-bulk voltage.
- **Absorption time**
 - The absorption time depends on whether the adaptive absorption time algorithm is used or not. If **Adaptive absorption time** is not enabled, the charger uses a **Fixed absorption time** that is user selectable and can be set down to 0. Now when the **Adaptive absorption time** is set, the charger will determine the absorption time based on the bulk elapsed time of that charge cycle. The **Maximum absorption time** is also set by the user in this case. The minimum value for this is 30 minutes.

9.3.3. Power Supply Mode

When on Power Supply Mode, these are the available settings.

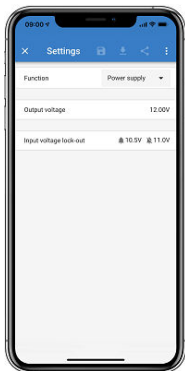

- **Function** allow to choose between “Charger” or “Power supply”. When power supply mode is selected, the Orion Smart will keep the output voltage as set on the setting.
- **Output voltage** allow to choose the output voltage when power supply mode is selected. Note that the minimum and maximum voltages needs to be within the product limit (i.e.: 10V to 15V for 12V output Orion Smart)
- **Input voltage lock-out** allow to choose between two thresholds. One to set the lock-out and another one to reset it. Normally, a minimum 0.5V (for 12V input Orion Smart) difference is used for a better performance. The protection can still be disabled if desired by the user. For more information about the input voltage lock-out, please read the [Orion Smart manual](#).

9.4. Product Information

By clicking the  button on the top right of the settings menu, it is possible to access the product information screen. See image below.

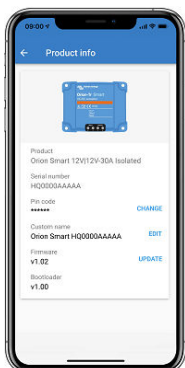

- **Product** shows the Orion Smart model
- **Serial number** shows the serial number of the unit
- **Pin code** allow the pin code to be changed. This is recommended to be done so settings and information won't be easy to access
- **Custom name** allow the product custom name to be changed to what the user wants. As default, it shows a short product name "Orion Smart" plus the serial number
- **Firmware** shows the current firmware version installed on the device and also allow the user to update the charger if desired
- **Bootloader** shows the bootloader firmware version



10. Appendix

10.1. Dimension drawing

